

Body-Solid[®]
Built for Life

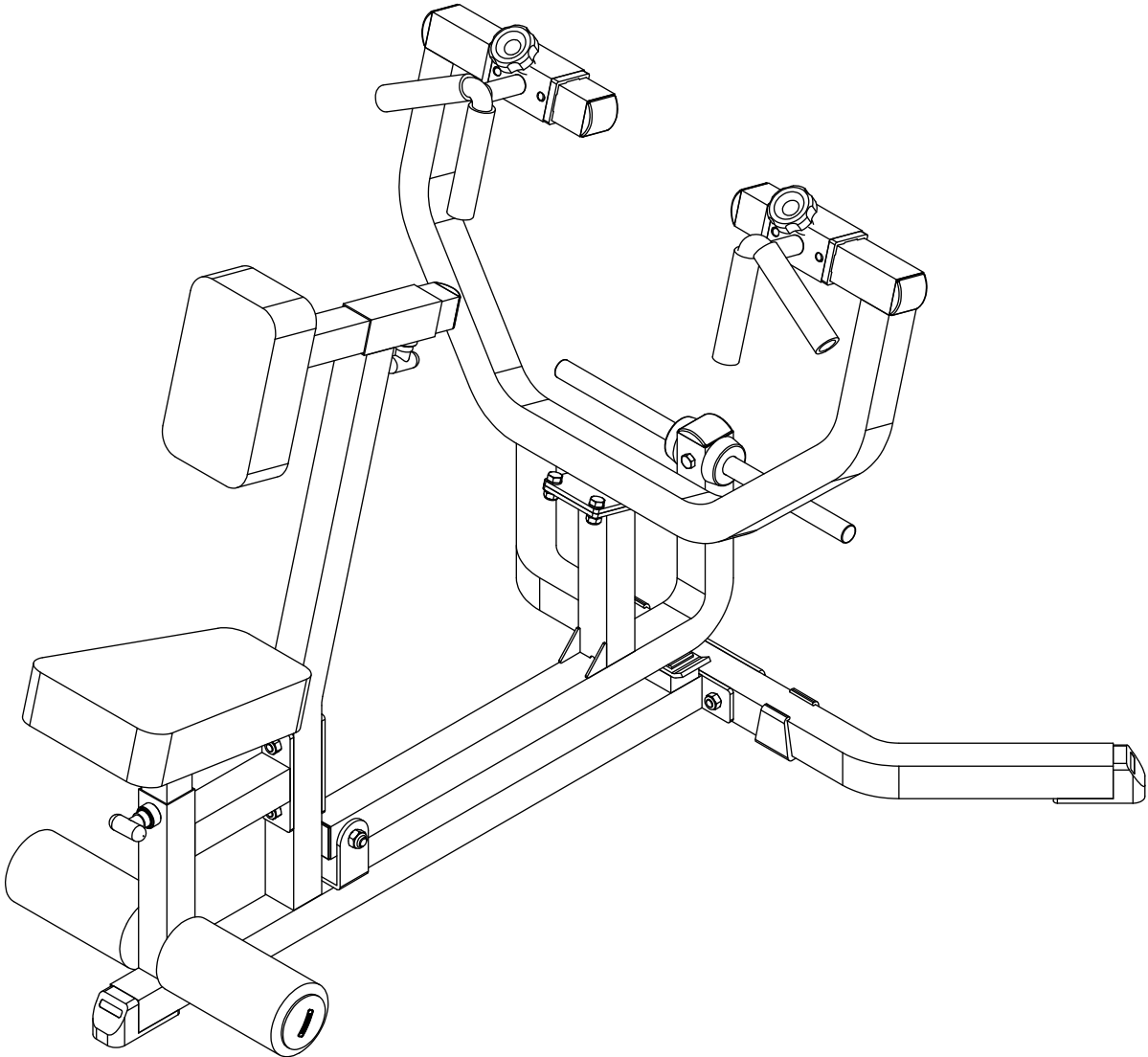

GSRM-40

Assembly & Instructions

OWNER'S & MANUAL

Hardware List (in scale)

KEY #1 HEX HEAD BOLT M12 X 75 PARTIAL THREAD QTY.4

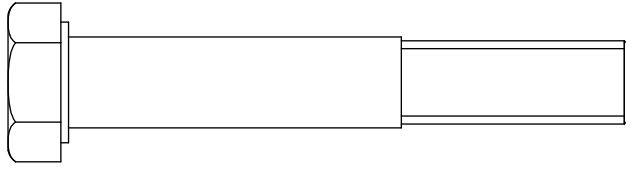

KEY #2 HEX HEAD BOLT M10 X 25 PARTIAL THREAD QTY.4

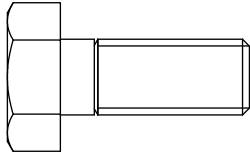

KEY #3 HEX HEAD BOLT 5/16" X 1" PARTIAL THREAD QTY.8

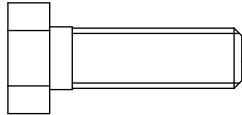

KEY #4 NYLON LOCK NUT M12 QTY.4

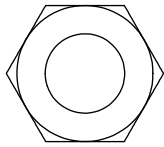
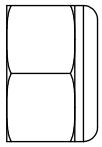

KEY #7 SPRING WASHER 5/16" QTY.8

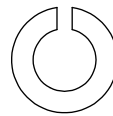

KEY #5 NYLON LOCK NUT M12 QTY.4

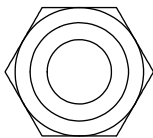
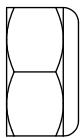

KEY #8 WASHER M10 (19 OD) QTY.8

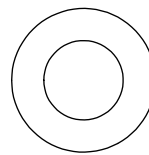

KEY #6 WASHER 5/16" (24 OD) QTY.8

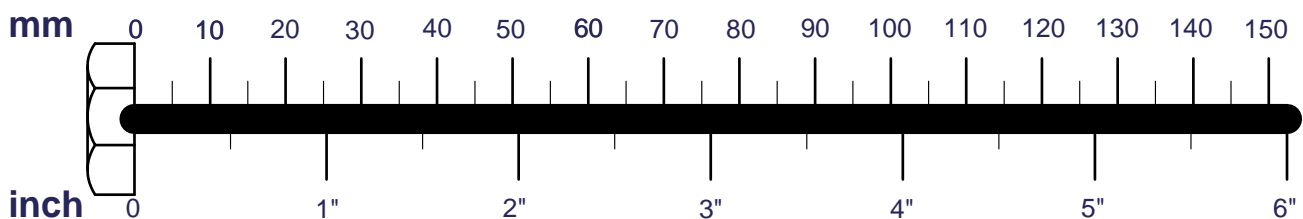
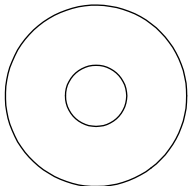

Hardware List

Part#	Qty	Description		
1	4	Hex Head Bolt	M12x75	
2	4	Hex Head Bolt	M10x25	
3	8	Hex Head Bolt	5/16"x1"	
4	4	Nylon Lock Nut	M12	
5	4	Nylon Lock Nut	M10	
6	8	Washer	5/16"	
7	8	Spring Washer	5/16"	
8	8	Washer	M10x19 OD	
9	2	Round End Cap	Ø1"	9211-022
10	5	Convex End Cap	2"x2"	9211-087
11	1	Convex End Cap	1 3/4"x1 3/4"	9211-091
12	4	Nylon Bushing	60x50	9211-033
13	2	Nylon Washer	Ø3"	9214-008
14	2	Foot Cap	2"x2"x1.8T	9211-024
15	1	Foot Cap	2"x2"x2.5T	9211-025
16	2	Rubber Clip	2"x2"	9212-010
17	2	Foam Roller	4"x23x8"	9161-054
18	2	Rubber Dount	Ø2 1/2"x3/4"	9310-012
19	1	Rubber Pad	1 1/2"x1 1/2"	9310-001
20	2	Rubber Dount V Style	Ø6xØ13	9214-004
21	1	Flat End Cap	2"x2"	9211-005
22	2	Pop Pin		8250-012
23	1	Hex Head Bolt	M10x20	
24	2	Nylon Lock Nut	1/2"	
25	1	Shaft	5/8"x105	8260-007
26	2	Copper Bushing		8520-002 pre-installed
27	2	Knob		9215-002 pre-installed
28	4	Foam Grip		9162-002 pre-installed
29	1	Right Sticker		9440-053 pre-installed
30	1	Left Sticker		9440-054 pre-installed
31	1	Maintenance Lable		9440-103 pre-installed
32	2	Pop Pin Sticker		9440-104 pre-installed
33	1	Warning Sticker		9440-105 pre-installed
34	1	BodySolid Logo		9440-027 pre-installed
35	1	BodySolid Plate		9440-199 pre-installed
36	1	Warning Sticker		9440-217 pre-installed

Mainframe List

Part#	Qty	Description	
A	1	Front Support	
B	1	Main Frame	
C	1	Upright Frame	
D	1	Support Shelf	
E	1	Adjustable Frame	
F	1	Seat Pad	9122-004
G	1	Seat Pad Adjustable Frame	
H	1	Back Pad	9132-006
I	1	Back Pad Adjustable Frame	
J	1	Right Handle Frame	
J-1	1	Left Handle Frame	
K	1	Foam Roller Bar	Ø1"x510
L	1	Foam Roller Bar	Ø1"x1.6Tx473
M	2	Plate	50x6Tx150 8312-062

GSRM - 40 EXPLODED VIEW

