

POWERLINE ^{USA}

by *Body-Solid*

PFID 125X

MULTI-BENCH

OWNER'S MANUAL

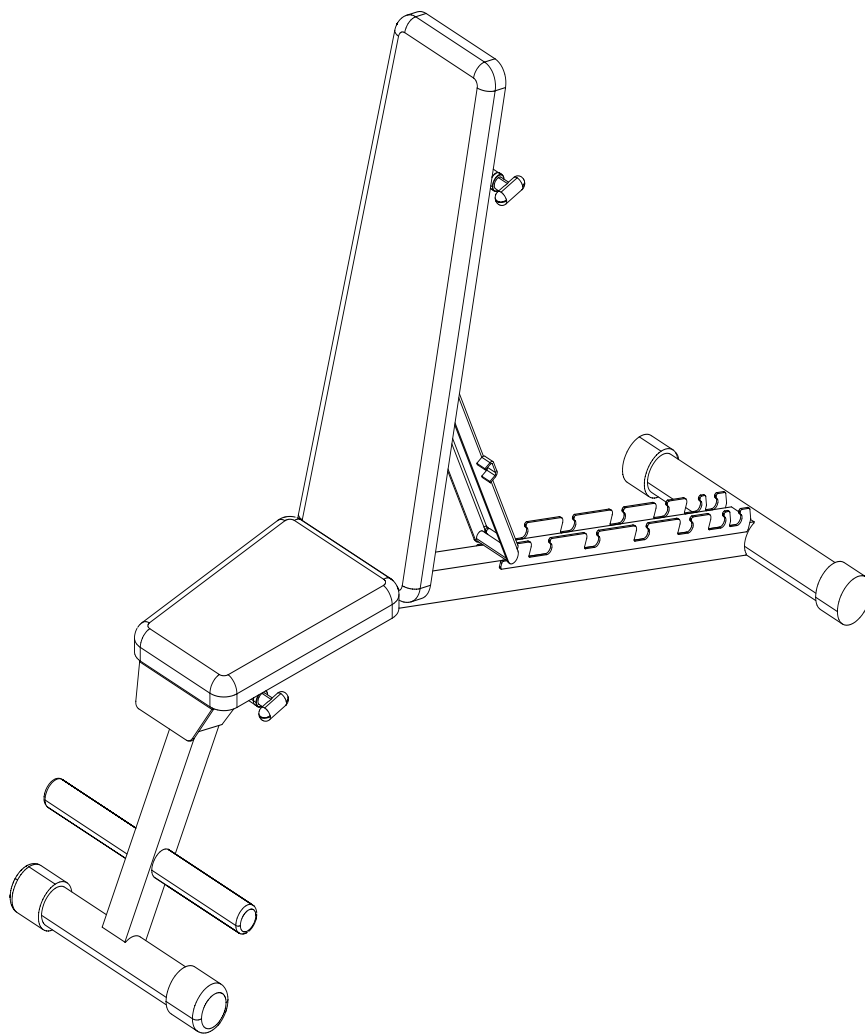

WWW.BODYSOLID.COM

V. 06012012

THERE IS A RISK ASSUMED BY INDIVIDUALS WHO USE THIS TYPE OF EQUIPMENT. TO MINIMIZE RISK, YOU MUST FOLLOW THESE RULES:

Inspect equipment before each workout. Check that all nuts, bolts, screws and pop pins are in place and fully tightened. Also, before use, check cables for sign of wear. Replace all worn parts immediately. Never use machine if any parts are damaged or missing.

FAILURE TO FOLLOW THESE RULES MAY RESULT IN SERIOUS INJURY.

Keep clear of the cables and all moving parts when machine is in use.

Always make sure all Snap Links are closed when doing cable/pulley/strap exercises.

Exercise with care. Perform your exercises at a smooth moderate pace; never perform jerky or uncoordinated movements that may cause injury.

It is recommended that you workout with a training partner.

Do not allow children or minors to play on or around this equipment.

If unsure of proper use of equipment, call your local Body-Solid distributor or the Body-Solid customer service center at 1-800-556-3113.

WARNING: Consult your physician before starting your exercise program. For your own safety, do not begin any exercise program without proper instruction.

WARNING

Safety and Maintenance of Cables

IMPORTANT: Cables are wear items. It is your responsibility to prevent unexpected breakage.

Cable inspection should be performed daily.

Inspect all cables, the nylon coating on all cables, and the area near the fitting at each end of each cable.

Replace any damaged or worn cable immediately.

Do not allow the machine to be used until damaged or worn cables are replaced. Using or allowing a machine to be used with a suspect cable can result in serious injury. See Owner's Manual for more information.

For Body-Solid Customer Service

Call 1-800-556-3113

**DO NOT REMOVE WARNING LABELS FROM
MANUAL OR MACHINE**

PFID 125x

TABLE OF CONTENTS

- **SAFETY INSTRUCTIONS..... PAGE 4**
- **PREPARATION..... PAGE 5**
- **HARDWARE LIST..... PAGE 6**
- **HARDWARE ILLUSTRATION..... PAGE 7**
- **PART LIST / ILLUSTRATION..... PAGE 9**
- **EXPLODED VIEW..... PAGE 10**
- **CONTACT PAGE..... PAGE 12**

PFID 125x

SAFETY INSTRUCTIONS

**WHEN USING EXERCISE EQUIPMENT,
YOU SHOULD ALWAYS TAKE BASIC
PRECAUTIONS INCLUDING THE
FOLLOWING:**

- Read all instructions before using the PFID125x. These instructions are written to ensure your safety and to protect the unit.
- **Do not remove any safety labels from the machine.**
- Do not allow children on or near the equipment.
- Use the equipment only for its intended purpose as described in this guide. Do not use accessory attachments that are not recommended by the manufacturer. Such attachments might cause serious injuries.
- Wear proper exercise clothing and shoes for your workout, no loose clothing.
- Keep hands, limbs, loose clothing, and long hair well out of the way of all moving parts
- Use care when getting on or off the unit.
- Do no overexert yourself or work to exhaustion.
- If you feel any pain or abnormal symptoms, stop your workout immediately and consult your physician.
- Never operate unit when it has been dropped or damaged. Return the equipment to a service center for examination and repair.
- Never drop or insert objects into any opening in the equipment.
- Always check the unit and its cables before each use. Make sure that all fasteners and cables are secure and in good working condition.
- Do not use the equipment outdoors or near water.
-

PERSONAL SAFETY DURING ASSEMBLY

- Before beginning assembly, please take the time to read the instructions thoroughly.
- Read each step in the assembly instructions and follow the steps in sequence. Do not skip ahead. If you skip ahead, you may learn later that you have to disassemble components and that you may have damaged the equipment
- Assemble and operate the PFID125x on a solid, level surface. Locate the unit a few feet from the walls or furniture to provide easy access.

The PFID125x is designed for your enjoyment. By following these precautions and using common sense, you will have many safe and pleasurable hours of healthful exercise with your Powerline Multi Bench.

After assembly, you should check all functions to ensure correct operation. If you experience problems, first recheck the assembly instructions to locate any possible errors made during assembly. If you are unable to correct the problem, call the dealer from whom you purchased the machine or call 1-800-556-3113 for the dealer nearest you.

OBTAINING SERVICE

Please use this Owner's Manual to make sure that all parts have been included in your shipment. When ordering parts, you must use the part number and description from this Owner's Manual. Use only Powerline by Body Solid replacement parts when servicing this machine. Failure to do so will void your warranty and could result in personal injury.

For information about product operation or service, check out the official Powerline website at www.bodysolid.com or contact an authorized Powerline dealer or a Powerline factory-authorized service company or contact Body-Solid customer service at one of the following:

Toll Free: 1-800-556-3113
Phone: 1-708-427-3555
Fax: 1-708-427-3556
Email: service@bodysolid.com

Or write to: Body-Solid, Inc.
Service Department
1900 S. Des Plaines Ave.
Forest Park, IL 60130 USA

**RETAIN THIS OWNER'S MANUAL FOR
FUTURE REFERENCE. PART NUMBERS
ARE REQUIRED WHEN ORDERING PARTS.**

PFID 125x

PREPARATION

REQUIRED TOOLS

The basic tools that you must obtain before assembling the PFID125x include but are not limit to:

- Standard Wrench Set
- Metric Wrench Set
- Adjustable Wrench
- Standard / Metric Allen Key Set

INSTALLATION REQUIREMENTS

Follow these installation requirements when assembling the PFID125x:

Set up the PFID125x on a solid, flat surface. A smooth, flat surface under the machine helps keep it level.

Provide ample space around the machine. Open space around the machine allows for easier access.

For aesthetic purposes, insert all bolts in the same direction unless specified (in text or illustrations) to do otherwise.

Leave room for adjustments. Tighten fasteners such as bolts, nuts, and screws so the unit is stable, but leave room for adjustments. Do not fully tighten fasteners until instructed in the assembly steps to do so.

Fill out and mail the warranty card.

ORDERING REPLACEMENT PARTS

If you need to order replacement parts please be prepared to provide the following information when contacting us so that we can assist you better.

1. Model Number
2. Place of Purchase
3. Serial Number (S/N)
4. Part # and Description

ASSEMBLY TIPS

Read all “Notes” on each page before beginning each step.

While you may be able to assemble the PFID125x using the illustrations only, important safety notes and other tips may be included in the text.

Some pieces may have extra holes that you will not use. Use only those holes indicated in the instructions and illustrations.

NOTE: With so many assembled parts, proper alignment and adjustment is critical. While tightening the nuts and bolts, be sure to leave room for adjustments.

NOTE: The bottles that are marked “Poison” is your touch up paint. Keep away from children.

CAUTION: Obtain assistance! If you feel like you can't assemble the PFID125x by yourself then do not attempt to do so as this could result in injury. Review the Installation Requirements before proceeding with the following steps.

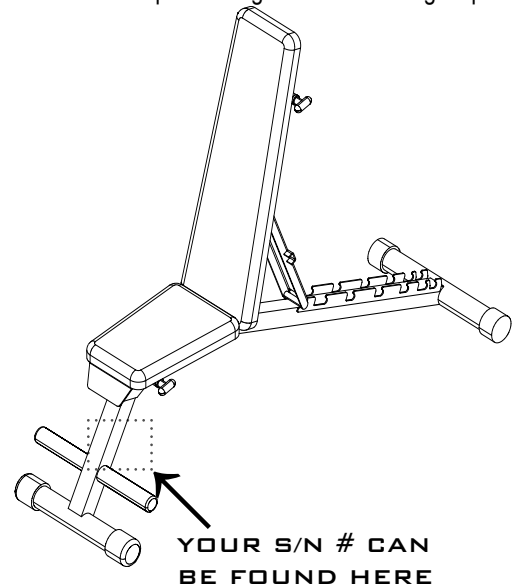

PFID 125x

HARDWARE LIST

<u>PART #</u>	<u>SIZE</u>	<u>DESCRIPTION</u>	<u>QUANTITY</u>
1	1	Folding Leg	1
2	1	Main Frame	1
3	1	Back Pad Adjuster	1
4	1	Back Pad Frame	1
5	1	Back Pad	1
6	1	Seat Pad	1
7	M8x20	Hex Head Bolt, Full Thread	6
8	M10x75	Hex Head Bolt, Partial Thread	1
9	M12x140	Hex Head Bolt, Partial Thread	2
10	M10	Nylon Lock Nut	1
11	M12	Nylon Lock Nut	2
12	M12	Washer	4
13	M10	Washer	2
14	M8	Spring Lock Washer	6
15		T-Shaped Pop Pin	2
16		Round Foot Cap	2
17		Round Foot Cap with Wheels	2
18		Rubber Tubing	2
19		Bushing	4
20	M8	Washer	6

PFID 125x

HARDWARE ILLUSTRATION

PART #7 **M8X20MM HEX HEAD BOLT** **QTY. 6**

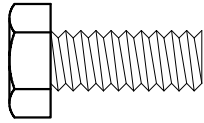

PART #8 **M10X75MM HEX HEAD BOLT** **QTY. 1**

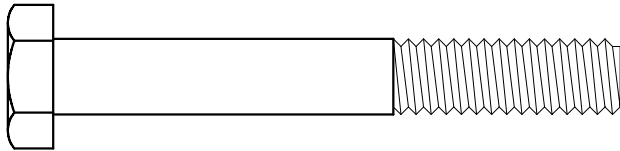

PART #9 **M12X140MM HEX HEAD BOLT** **QTY. 2**

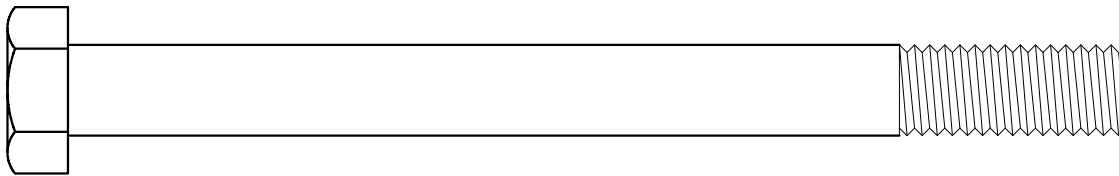

PART #10 **M10 NYLON LOCK NUT** **QTY. 1**



PART #11 **M12 NYLON LOCK NUT** **QTY. 2**

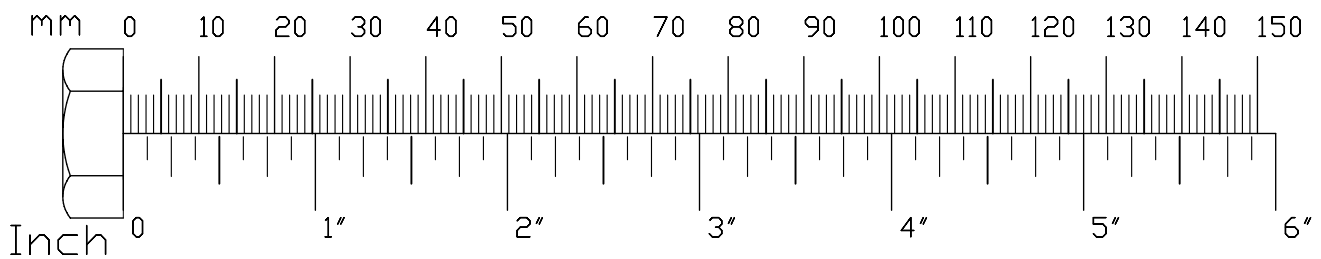
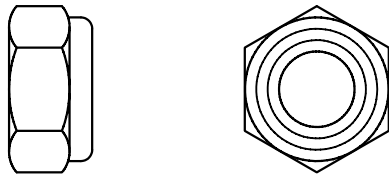

PFID 125x

HARDWARE ILLUSTRATION CONT.

PART # 12

M12 WASHER

QTY. 4

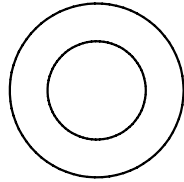
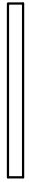

PART # 13

M10 WASHER

QTY. 2

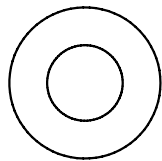
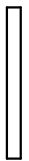

PART # 14

M8 SPRING LOCK WASHER

QTY. 6

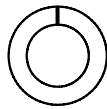

PART # 20

M8 WASHER

QTY. 6

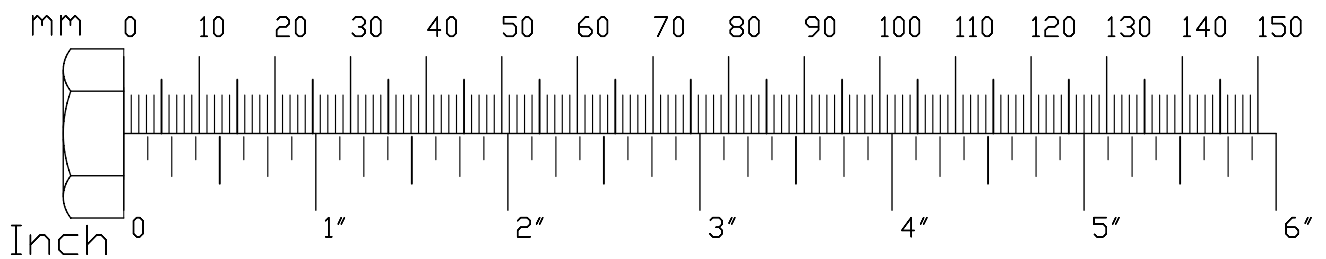
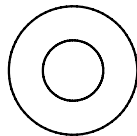

PFID 125x

PART LIST

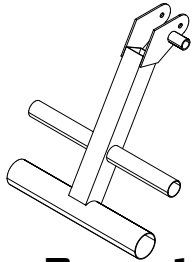

PART 1
FOLDING LEG
[1 PCS]

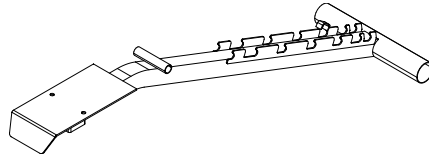

PART 2
MAIN FRAME
[1 PCS]

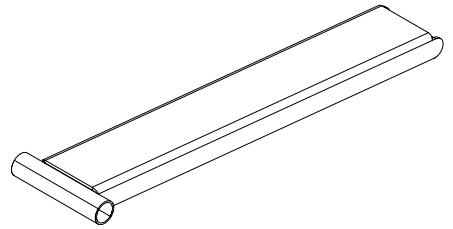

PART 3
BACK PAD ADJUSTER
[1 PCS]

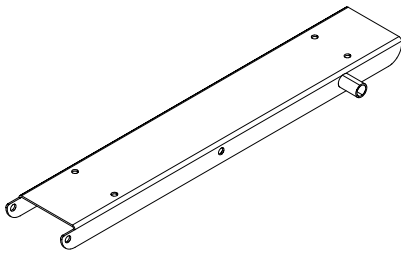

PART 4
BACK PAD FRAME
[1 PCS]

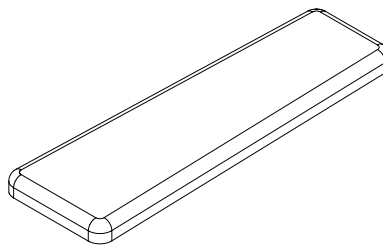

PART 5
BACK PAD
[1 PCS]

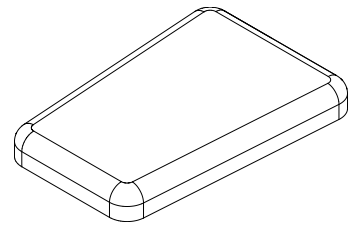

PART 6
SEAT PAD
[1 PCS]

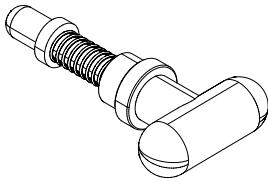

PART 15
T-SHAPED POP PIN
[2 PCS]

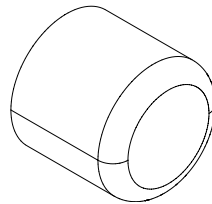

PART 16
ROUND FOOT CAP
[2 PCS]

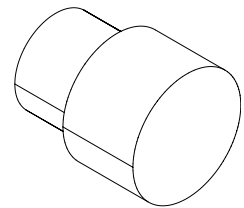

PART 17
ROUND FOOT CAP
WITH WHEELS
[2 PCS]

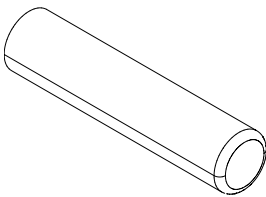

PART 18
RUBBER TUBING
[2 PCS]

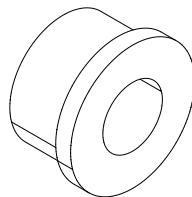

PART 19
BUSHING
[4 PCS]

PFID 125x

EXPLODED VIEW

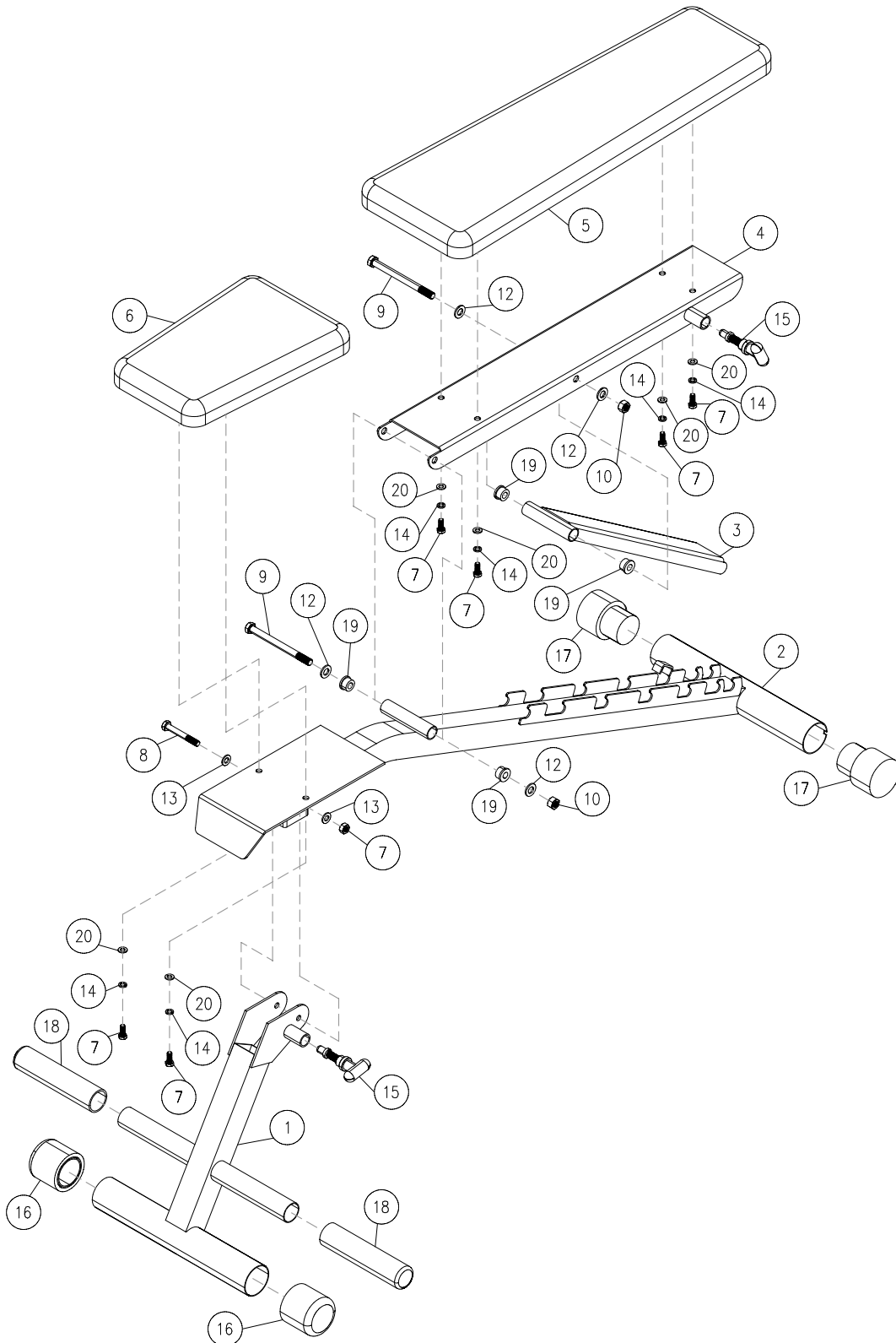

PFID 125x

NOTES



PFID 125x

PLEASE WRITE YOUR SERIAL NUMBER IN THE BOXES BELOW

S/N # 001558-□□-□□-□□□□-□□□□

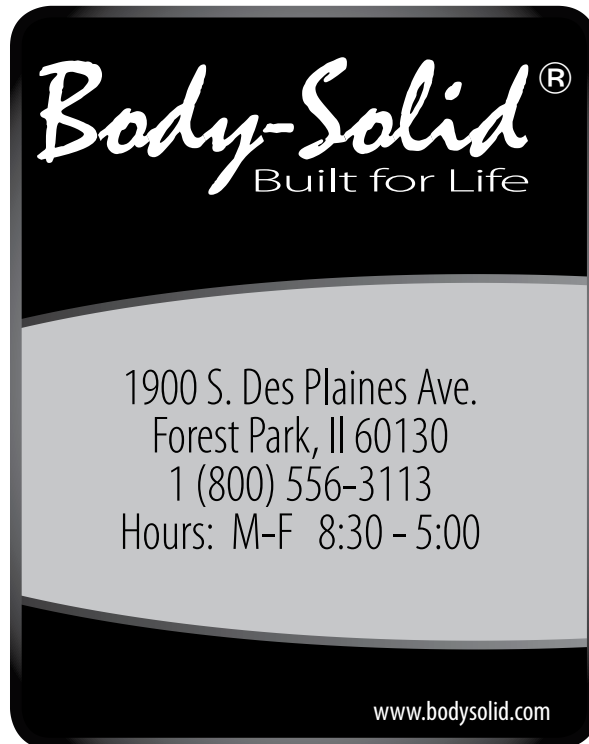

© Copyright 2009. Body-Solid. All rights reserved. Body-Solid reserves the right to change design and specifications when we feel it will improve the product. Body-Solid machines maintain several patented and patent pending features and designs. All rights reserved on all design patents and utility patents.