

# Body-Solid® ProClubLine

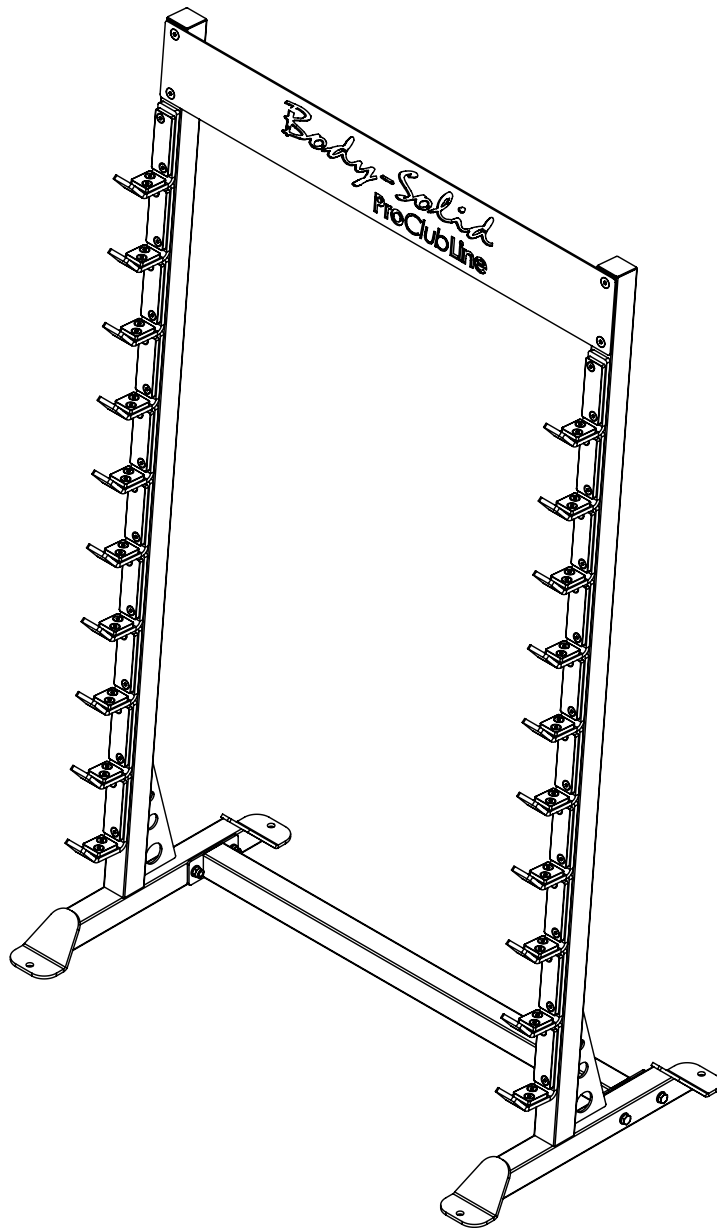

## SBS100

Assembly Instructions

**OWNER'S & MANUAL**

V. SBS100-20191025

## Warning, Safety & Maintenance

Be sure that all users carefully read and understand all warning, safety and maintenance labels on the machine before each use. Failure to do so may result in death or serious injury.

It is imperative that you retain this Owner's Manual and be sure all warning labels are legible and intact. Replacement Owner's Manuals and warning labels are available from your local Body-Solid dealer.

If you have any questions about the operation, set up or maintenance of this machine please call our customer service department at 1 (800) 556-3113.

**THERE IS A RISK ASSUMED BY INDIVIDUALS WHO USE THIS TYPE OF EQUIPMENT. TO MINIMIZE RISK, YOU MUST FOLLOW THESE RULES:**

1. Inspect equipment before each workout. Check that all nuts, bolts, screws and pop pins are in place and fully tightened. Also, before use, check cables for signs of wear. Replace all worn parts immediately. Never use machine if any parts are damaged or missing.  
**FAILURE TO FOLLOW THESE RULES MAY RESULT IN SERIOUS INJURY.**
2. Keep clear of the cables and all moving parts when the machine is in use.
3. Always make sure all Snap Links are closed when doing any cable/pulley/strap exercises.
4. Exercise with care. Perform your exercises at a smooth moderate pace; never perform jerky or uncoordinated movements that may cause injury.
5. It is recommended that you should workout with a training partner.
6. Do not allow children or minors to play on or around this equipment.
7. If unsure of proper use of equipment, call your local Body-Solid distributor or the Body-Solid customer service department at 1-800-556-3113.
8. **WARNING:** Consult your physician before starting your exercise program. For your own safety, do not begin any exercise program without proper instruction. RAL8-6-03 WC-54

## Table of Contents

- SAFETY INSTRUCTIONS..... PAGE 4
- PREPARATION..... PAGE 5
- HARDWARE ILLUSTRATION..... PAGE 6
- PART / HARDWARE LIST..... PAGE 7
- ASSEMBLY INSTRUCTIONS..... PAGE 8
- EXPLODED VIEW..... PAGE 11
- CONTACT PAGE..... PAGE 12

# Important Safety Instructions

Before beginning any fitness program, you should obtain a complete physical examination from your physician.

*Il est conseillé de subir un examen médical complet avant d'entreprendre tout programme d'exercice.  
Si vous avez des étourdissements ou des faiblesses, arrêtez les exercices immédiatement.*

*Antes de comenzar cualquier programa de ejercicios, deberías tener un examen físico con su doctor.*

## **When using exercise equipment, you should always take basic precautions, including the following:**

- Read all instructions before using the **SBS100**. These instructions are written to ensure your safety and to protect the unit.
- **Do not remove any safety labels from the machine.**
- Do not allow children on or near the equipment.
- Use the equipment only for its intended purpose as described in this guide. Do not use accessory attachments that are not recommended by the manufacturer. Such attachments might cause injuries.
- Wear proper exercise clothing and shoes for your workout, no loose clothing.
- Keep hands, limbs, loose clothing, and long hair well out of the way of all moving parts.
- Use care when getting on or off the unit.
- Do not overexert yourself or work to exhaustion.
- If you feel any pain or abnormal symptoms, stop your workout immediately and consult your physician.
- Never operate unit when it has been dropped or damaged. Return the equipment to a service center for examination and repair.
- Never drop or insert objects into any opening in the equipment.
- Always check the unit and its cables before each use. Make sure that all fasteners and cables are secure and in good working condition.
- Do not use the equipment outdoors or near water.

## **Personal Safety During Assembly**

- Before beginning assembly, please take the time to read the instructions thoroughly.
- Read each step in the assembly instructions and follow the steps in sequence. Do not skip ahead. If you skip ahead, you may learn later that you have to disassemble components and that you may have damaged the equipment.
- Assemble and operate the **SBS100** on a solid, level surface. Locate the unit a few feet from the walls or furniture to provide easy access.

The **SBS100** is designed for your enjoyment. By following these precautions and using common sense, you will have many safe and pleasurable hours of healthful exercise with your Body-Solid **Bar Rack**.

After assembly, you should check all functions to ensure correct operation. If you experience problems, first recheck the assembly instructions to locate any possible errors made during assembly. If you are unable to correct the problem, call the dealer from whom you purchased the machine or call **1-800-556-3113** for the dealer nearest you.

## **Obtaining Service**

Please use this Owner's Manual to make sure that all parts have been included in your shipment. When ordering parts, you must use the part number and description from this Owner's Manual. Use only Body-Solid replacement parts when servicing this machine. Failure to do so will void your warranty and could result in personal injury.

For information about product operation or service, check out the official Body-Solid website at [www.bodysolid.com](http://www.bodysolid.com) or contact an authorized Body-Solid dealer or a Body-Solid factory-authorized service company or contact Body-Solid customer service at one of the following:

**Toll Free: 1-800-556-3113**  
**Phone: 1-708-427-3555**  
**Fax: 1-708-427-3556**  
**Hours: M-F 8:30-5:00 CST**  
**E-Mail: [service@bodysolid.com](mailto:service@bodysolid.com)**

**Or write to:           Body-Solid, Inc.**  
**Service Department**  
**1900 S. Des Plaines Ave.**  
**Forest Park, IL 60130 USA**

**Retain this Owner's Manual for future reference. If you need to order replacement parts please be prepared to provide the following information when contacting us so that we can assist you better.**

- 1. Model Number**
- 2. Place of Purchase**
- 3. Serial Number (S/N)**
- 4. Part # and Description**

# Preparation

Thank you for purchasing the **SBS100**. This Product is part of the Body-Solid line of quality strength training machines, which lets you target specific muscle groups to achieve better muscle tone and overall body conditioning. To maximize your use of the equipment please study this Owner's Manual thoroughly.

## Required Tools

The basic tools that you must obtain before assembling the **SBS100** include but are not limited to:

- Standard Wrench Set
- Metric Wrench Set
- Adjustable Wrench

## Installation Requirements

Follow these installation requirements when assembling the **SBS100**:

Set up the **SBS100** on a solid, flat surface. A smooth, flat surface under the machine helps keep it level. A level machine has fewer malfunctions.

Provide ample space around the machine. Open space around the machine allows for easier access.

Insert all bolts in the same direction. For aesthetic purposes, insert all bolts in the same direction unless specified (in text or illustrations) to do otherwise.

Leave room for adjustments. Tighten fasteners such as bolts, nuts, and screws so the unit is stable, but leave room for adjustments. Do not fully tighten fasteners until instructed in the assembly steps to do so.

**Fill out and mail the warranty card.**

## Assembly Tips

Read all "Notes" on each page before beginning each step.

While you may be able to assemble the **SBS100** using the illustrations only, important safety notes and other tips are included in the text.

Some pieces may have extra holes that you will not use. Use only those holes indicated in the instructions and illustrations.

**NOTE:** With so many assembled parts, proper alignment and adjustment is critical. While tightening the nuts and bolts, be sure to leave room for adjustments.

**CAUTION:** Obtain assistance! If you feel like you can't assemble the **SBS100** by yourself then do not attempt to do so as this could result in injury. Review the installation requirements before proceeding with the following steps.

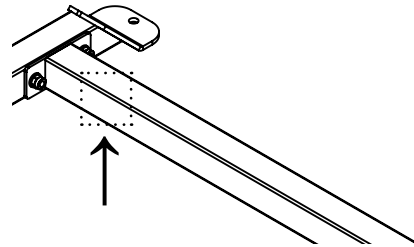

Your S/N# can  
be found here

Body-Solid continually seeks ways to improve the performance, specifications and product manuals in order to ensure that only superior products are released from our factories. Please take the time to carefully read through this manual thoroughly. Instructions contained in this document are not intended to cover all details or variations possible with Body-Solid equipment, or to cover every contingency that may be met in conjunction with installation, operation, maintenance or troubleshooting of the equipment. Even though we have prepared this manual with extreme care, neither the publisher nor the author can accept responsibility for any errors in, or omission from, the information given. Should additional information be required, or should situations arise that are not covered by this manual, the matter should be directed to your local Body-Solid representative, or the Service Department at Body-Solid Inc. in Forest Park, Illinois.

# SBS100 Hardware Illustration

Part #1      HEX HEAD BOLT M10x70mm

QTY. 4

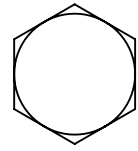
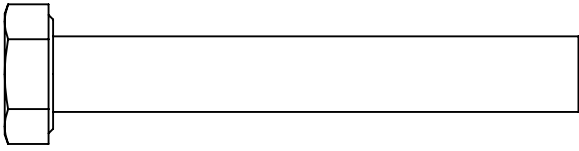

Part #2      FLAT HEAD CAP SCREW M10x70mm

QTY. 4

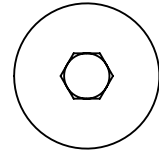
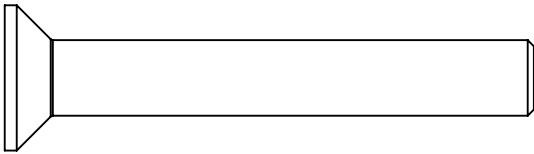

Part #3      ULTRA LOW PROFILE HEAD CAP SCREW M8x10mm

QTY. 80

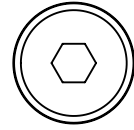
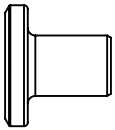

Part #4      FLAT WASHER M10

QTY. 12

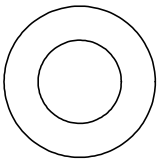

Part #5      NYLON LOCK NUT M10

QTY. 8

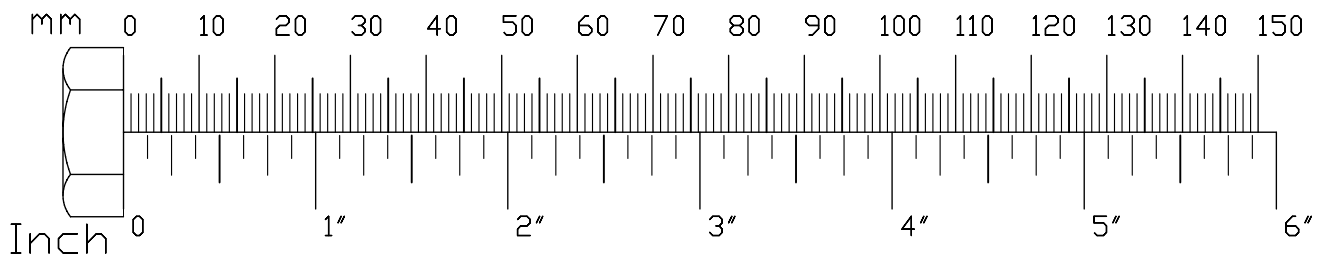
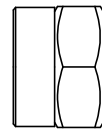
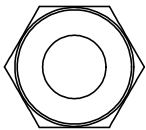

## SBS100 Parts & Hardware List

| <b>Part#</b> | <b>Qty</b> | <b>Description</b>                    |
|--------------|------------|---------------------------------------|
| A            | 1          | BASE FRAME                            |
| B            | 2          | UPRIGHT                               |
| C            | 3          | LOGO PLATE                            |
| 1            | 4          | HEX HEAD BOLT M10x70mm                |
| 2            | 4          | FLAT HEAD CAP SCREW M10x70mm          |
| 3            | 80         | ULP CAP SCREW M8x10mm (Pre-Installed) |
| 4            | 12         | M10 FLAT WASHER                       |
| 5            | 8          | M10 NYLON LOCK NUT                    |
| 7            | 20         | LARGE PLASTIC PAD (Pre-Installed)     |
| 8            | 20         | SMALL PLASTIC PAD (Pre-Installed)     |

## STEP

# 1

**Be careful to assemble all components in the sequence they are presented.**

**NOTE:**

**Wrench tighten ALL hardware at the end of STEP 1B. Some components may be pre-assembled. Nylon lock nuts will not fully screw onto bolts, they must be wrench tighten to fully go on.**

- 1A.** Attach Uprights **(B)** to Base Frame **(A)** using:
  - 4 - (#1) M10x70mm Hex Head Bolt**
  - 8 - (#4) M10 Flat Washer**
  - 4 - (#5) M10 Nylon Lock Nut**
  
- 1B.** Attach Uprights **(B)** to Logo Plate **(C)** using:
  - 4 - (#1) M10x70mm Flat Head Cap Screw**
  - 4 - (#4) M10 Flat Washer**
  - 4 - (#5) M10 Nylon Lock Nut**



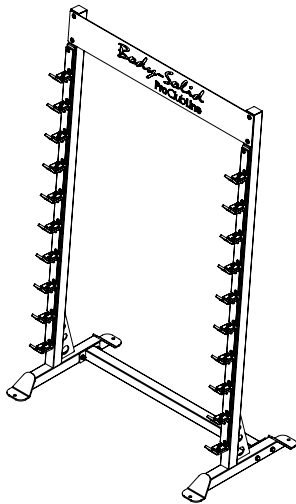

Above shows Step 1 assembled and completed.

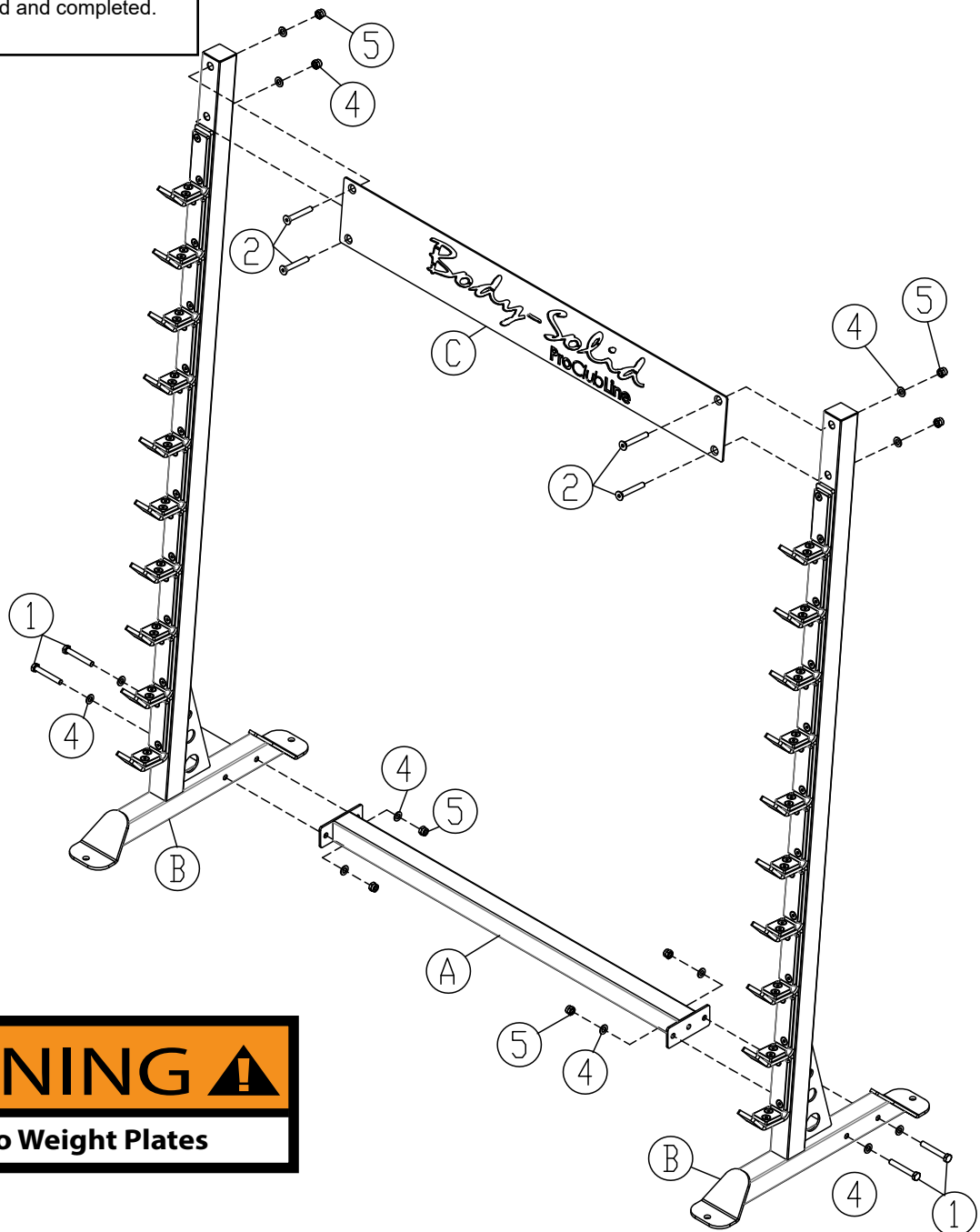

**⚠ WARNING ⚠**  
**Bars ONLY - No Weight Plates**

# Notes

# SBS100 Exploded View

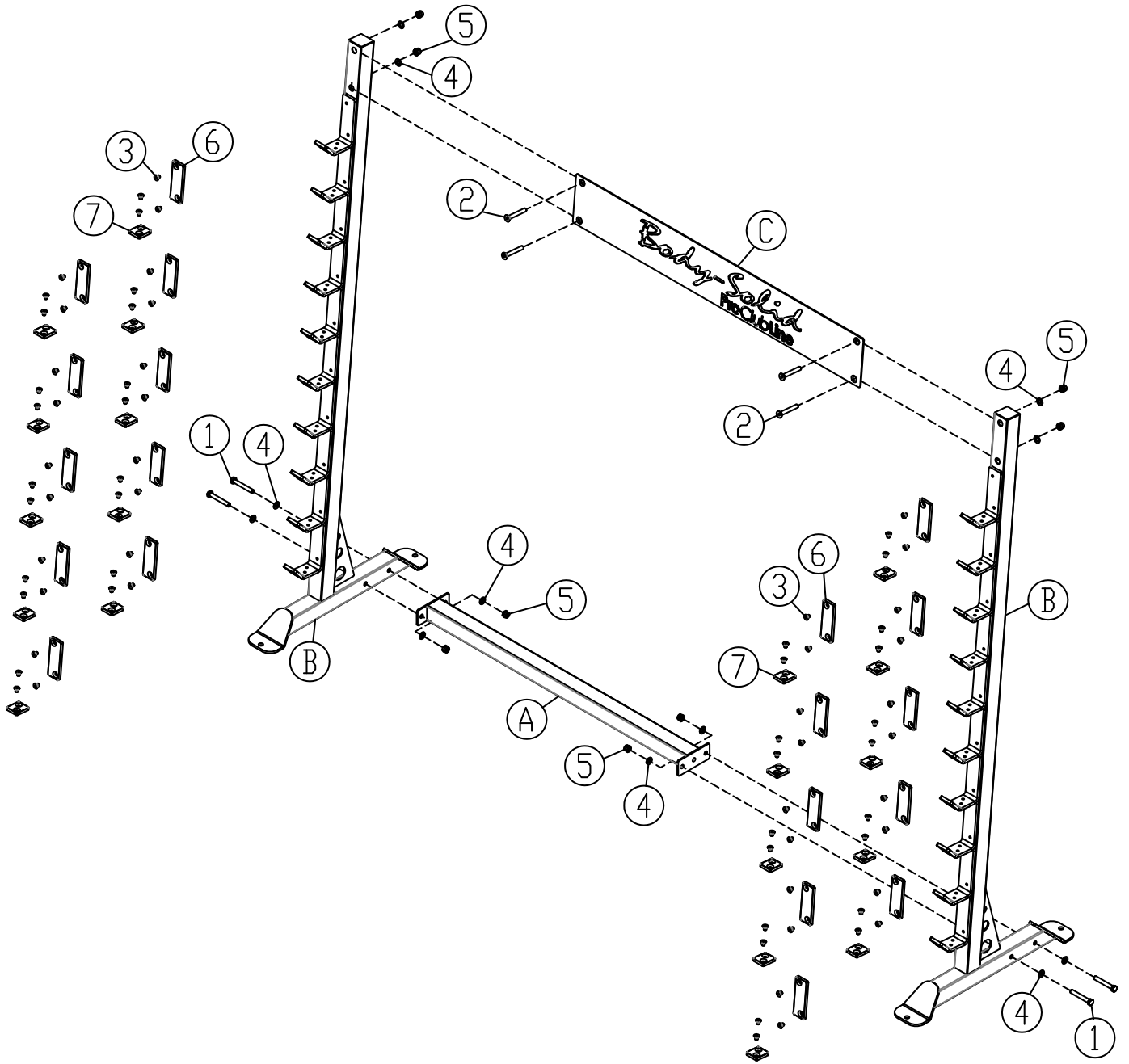

# Body-Solid® ProClub Line

## SBS100

PLEASE WRITE YOUR SERIAL NUMBER IN THE BOXES BELOW

S/N # 015470-□□-□□-□□□□-□□□□

1900 S. Des Plaines Ave.  
Forest Park, IL 60130  
Phone:(708)427-3555  
Fax:(708)427-3556  
Hours: M-F 8:30 - 5:00 CST

*www.bodysolid.com*