

SWT-14

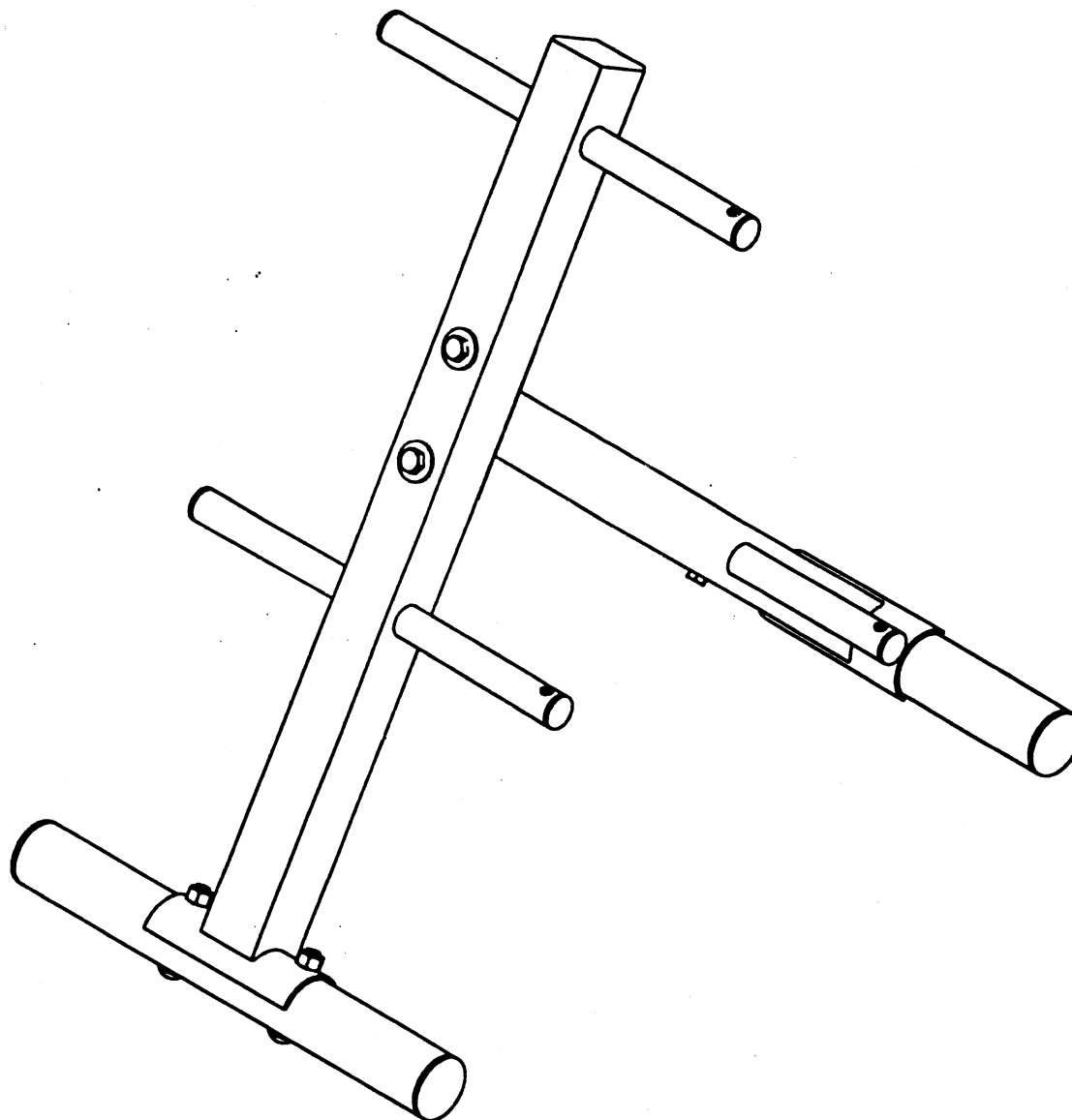

VERSION 0105

SWT-14

HARDWARE ILLUSTRATION SHEET

	Qty.
A1. M10X65L CARRIAGE BOLT -----	[4PCS]
A2. M10X65L HEX HEAD BOLT -----	[2PCS]
B1. M10 LOCK NUT-----	[6PCS]
C1. M10 (I.D) WASHER-----	[2PCS]
D1. ø1" ROUND END CAP (9211-016)-----	[6PCS]
D2. ø50 ROUND END CAP (9211-020) -----	[4PCS]
D3. 2"X2"X2.5t END CAP (9211-006) -----	[1PCS]

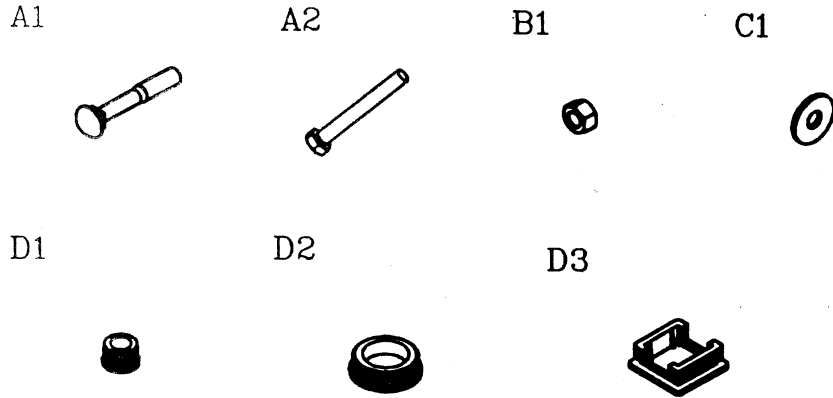

PARTS ILLUSTRATION SHEET

A[1PCS]

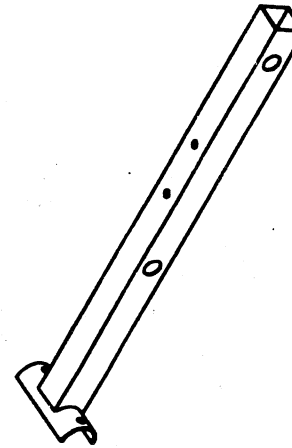

B[1PCS]

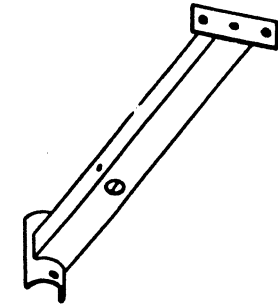

C[2PCS]

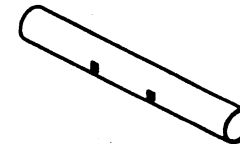

D[3PCS]

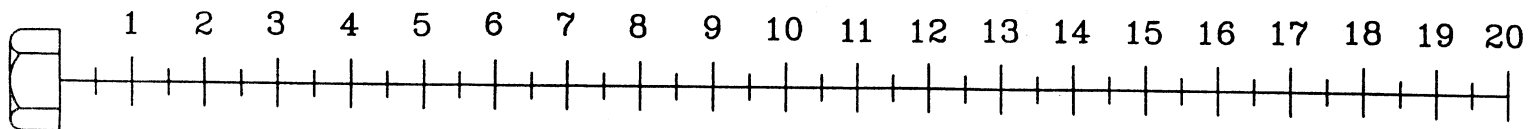
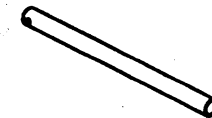

SWT-14

